

WIPCOOL®

IDEAL PRODUCTS FOR HVAC

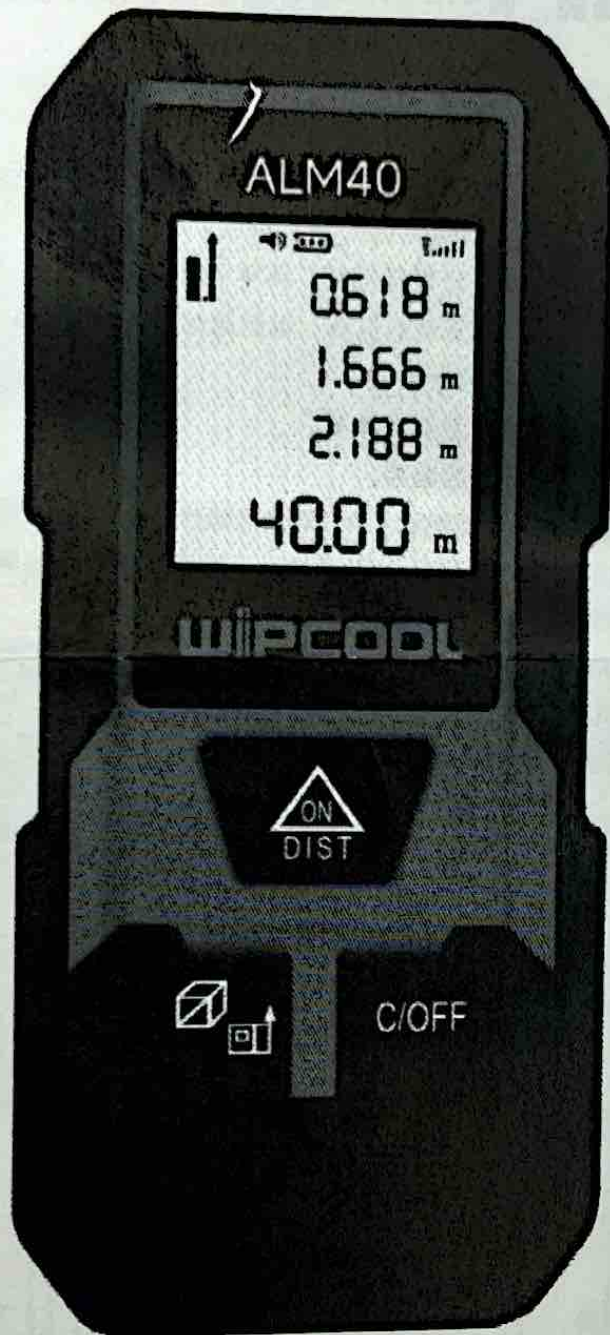

**Laser Distance Meter
ALM40
Operational Manual**

Thank you for purchasing our ALM40 hand-held laser distance meter.

⚠ Please read the terms and instructions carefully before using the instrument for the first time.

1. Safety rules

⚠ Before using the instrument, please read all clauses and operating instructions in this manual carefully. Failure to follow the operating instructions may cause damage to the instrument, affect the measuring accuracy, or cause personal injury to the user or a third party.

⚠ Do not attempt to open or repair the instrument by yourself in any way. It is strictly prohibited to illegally modify or change the performance of the instrument laser transmitter. Please take good care of the instrument. Do not put it in a place where children can reach it. Do not use it by irrelevant persons.

It is forbidden to illuminate the eyes and other parts of the body with the instrument laser.
It is forbidden to illuminate the laser on the surface of strongly reflective objects.

⚠ Do not place the instrument within the reach of children.

Do not repair this instrument without authorization. If the instrument is damaged, contact your local dealer

Electromagnetic radiation may interfere with local equipment or devices (e.g. medical devices such as pacemakers or hearing AIDS).

- Do not use this instrument in flammable or explosive environment.
- Do not use this instrument near medical equipment.
- Do not use this instrument on aircraft.

Dispose of discarded instruments in accordance with the law of your locality.

2. Buttons and display

Buttons:

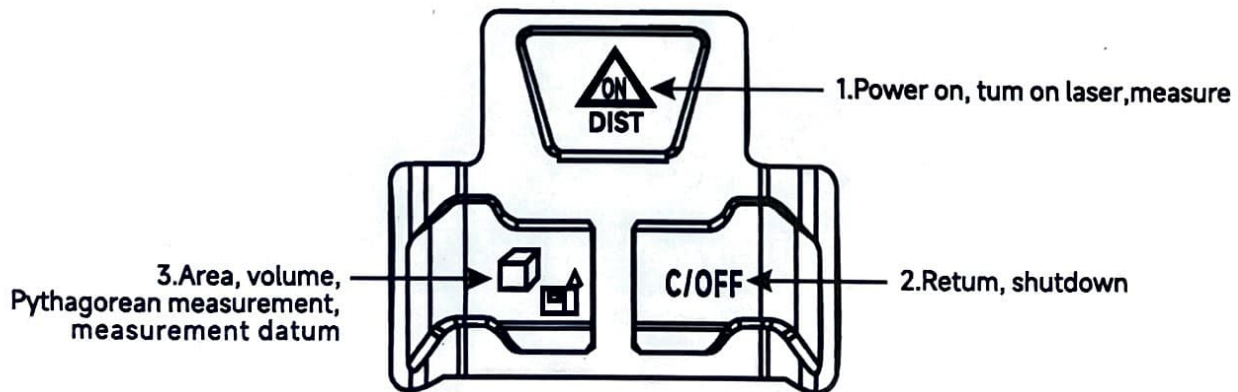

Full screen display:

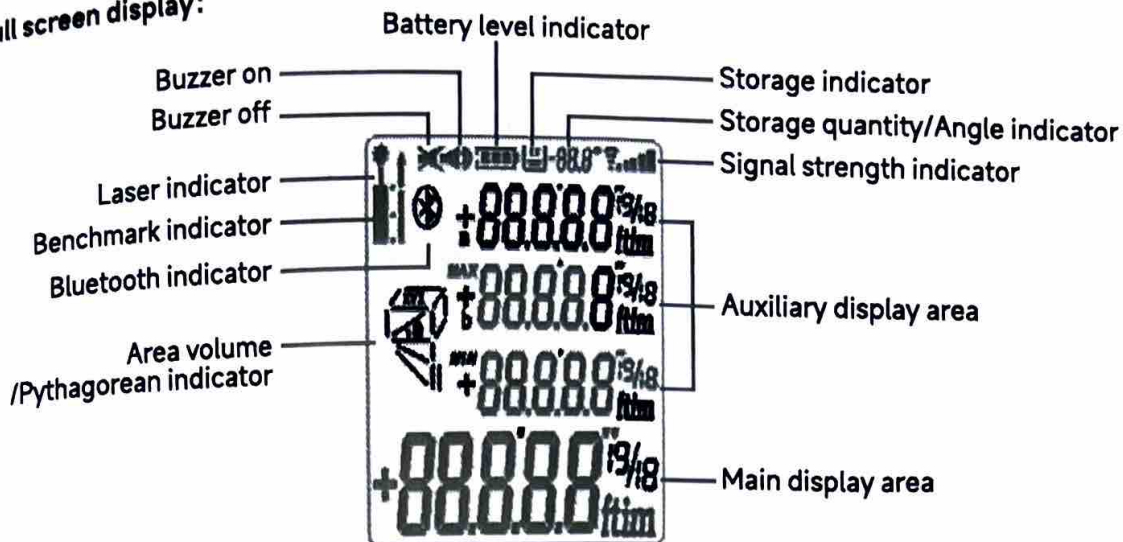

3. Starting up

Install/replace batteries:

Open the battery compartment cover, put the battery into the battery compartment correctly, and cover back the battery compartment cover. When the battery power is too low, the icon representing low battery power will appear on the display screen. Please replace the battery as soon as possible. Carbon or alkaline batteries can be used normally, and the measurement times of carbon batteries will be relatively reduced.

- Remove the battery when it is not in use for a long time.
- Lithium battery can be directly turned on for use. If the voltage is too low, please timely charge the instrument.
- When the battery level indicator is displayed, it indicates that the battery level is low and the battery needs to be replaced.

4. Operation

• **Start the machine:** Press the first button in the shutdown state for about 0.5 seconds to start the machine, When no button is pressed, It will turn off the backlight automatically after about 15 seconds.

• **Turn on laser/measurement:** when the machine is on, short press the first key to turn on the laser or measure the distance, long press the key to enter the continuous measurement mode. The display icon "  " on the display screen indicates the strength of measured reflected signal, and the number of displayed segments decreases, indicating the relative weakness of measured reflected signal.

• **Benchmark switch:** long press the third key for about 2 seconds in the machine on state to switch benchmark, and restore the default benchmark after restarting.

• **Shutdown:** when the machine is on, press the second button for about 1 second to shut it down. When no button is pressed, it will shut down automatically after 45 seconds.

• **Setting up:** long press the first key for about 5 seconds to enter the setting state in the shutdown state, and the measured value can be corrected within the range of +/-7mm; Can be set in metric or imperial units; Can set backlight and buzzer. Press the first key for about 1 second during setting time to switch Settings, and short press the first key to adjust set value



Area measurement:

Short press the third key, display screen will display the icon "  ", prompt to enter area measurement mode, at this time the long sides of the rectangle icon flashing, after locking measurement point, press the button on the first side long measurement, and then in the second side of the rectangle icon flashing, locking points again, press button on the second side length measurement, the instrument will automatically area calculation, calculation result is displayed in the main display area, the first and second side length measurement results show that in the auxiliary display area.

Volume measurement

Short press the third button until the icon "  " appears on the display screen, indicating that the volume measurement mode is entered, and the volume measurement is completed according to the operation similar to area measurement.

Pythagorean measurement

The instrument presets three modes of measuring the length of the right side of a triangle by using Pythagorean theorem, including "  ", "  " and "  ". Short press the third button until the corresponding function icon appears on the display screen, and complete the corresponding function measurement according to the operation of similar area measurement.

Note: in the Pythagorean theorem measurement mode, the right Angle side must be less than the hypotenuse length, otherwise the instrument will prompt the error message "D.E".

5.Prompt code and solution

In the process of using the instrument, the following prompt information may appear:

Information	Cause	Solution method
B.L	Battery voltage is too low	Replace or charge the battery
T.L	The temperature is too low	Heat up the instrument
T.H	The temperature is too high	Cool the instrument
D.E	Measurement data error	Over range or Pythagorean measurement error

6.Technical data

Accuracy of measurement	±5mm*
unit	m/in/ft
Measuring range (no reflector)	0.03-40m**
Measuring time	0.3-4 seconds
Laser type	620-670nm, <1mw
Self-closing laser	15 seconds
Automatic shutdown	45 seconds
Display lighting	White LED
Switch of measurement datum	√
Power display	√
Battery type and life	2*1.5V AAA Alkaline batteries, Single measurement, about 5,000 times
Product size	90*40*24mm
The weight of the product	---
Operating temperature range	0 C° ~ 40 C°
Storage temperature range	-20 C° ~ 60 C°

* Under good measuring conditions (good measuring surface, room temperature), the measurement error can be up to 10 meters, and under bad measuring conditions (such as too strong ambient light, too large or too small diffuse reflection coefficient of the measured point, too large temperature difference, etc.), the measurement error can be up to ±0.25mm/m.

**In the case of strong daylight or poor reflection of the target, please use the aiming board!

7.Maintenance

Do not immerse the instrument in water. Use a wet soft cloth to wipe dirt off the surface. Do not use an aggressive lotion. Wipe the surfaces of the optical parts (including the laser exit window and the signal receiving lens) in the same way as you would wipe glasses and camera lenses.