

UNT6215Z

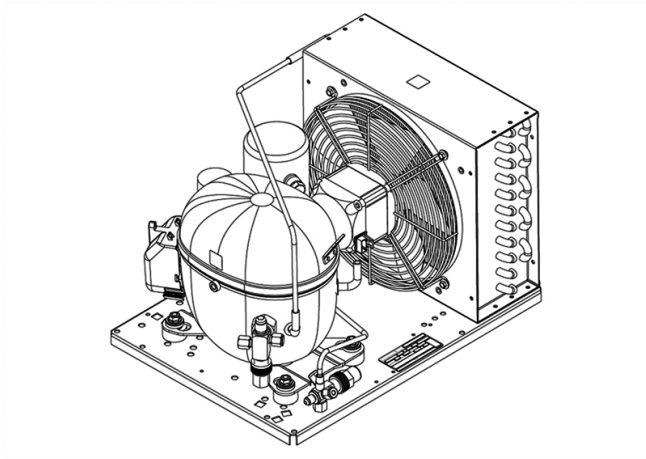

ENGINEERING CODE
602AN5212AA



REFRIGERANT
R-513A



POWER SUPPLY
200-240 V 50 Hz
/ 230 V 60 Hz



APPLICATION
HBP



MOTOR TYPE
CSIR



STANDARD
EN13215_RG20

CE

ECODESIGN
COMPLIANT



COOLING CAPACITY
881 W



EFFICIENCY
1.6 W/W

DATA

GENERAL DATA

Model UNT6215Z

ELECTRICAL DATA

Locked Rotor Amperage (LRA) 22.00 A

Rated Load Amperage (RLA) 5.12 A

Maximum Overcurrent Protection (MOP) 11.52 A

Minimum Current Ampacity (MCA) 6.4 A

ACCESSORIES

Discharge valve FLARE 1/4" 2110025

Suction valve FLARE 3/8" 2110056

CONDENSING COMPONENTS

Compressor NT6215Z M/HBP

Condenser 3R11T 2451206

Refrigerant R-134a

Expansion Device C-V

Fan Blade Diameter 254 mm

Fankit 25W 254/28/5B 1996587

MECHANICAL DATA

Air Flow	740 m ³ /h
Height	296 mm
Receiver	1.2 L
Shaft Power	25 W
Weight	28 Kg
Width	340 mm
Length	465 mm

PERFORMANCE

TESTED CONDITIONS

Tested Refrigerant	R-513A
Tested Application	HBP
Tested Standard	EN13215_RG20

RATED POINTS

Ambient Temperature °C	Evaporating Temperature °C	Cooling Capacity W	Efficiency W/W	Consumo de Potencia W
32	-10	881	1.6	549

Test Condition: Subcooling 3 K, Return Gas 20 °C.

PERFORMANCE CURVE

Ambient Temperature 25°C

Evaporating Temperature °C	Cooling Capacity W	Efficiency W/W	Consumo de Potencia W
-15	784	1.64	477
-5	1172	1.98	592
0	1379	2.12	652
5	1600	2.23	716
10	1835	2.33	787

Test Condition: Subcooling 3 K, Return Gas 20 °C.

PERFORMANCE CURVE

Ambient Temperature 32°C

Evaporating Temperature °C	Cooling Capacity W	Efficiency W/W	Consumo de Potencia W
-15	709	1.44	492
-5	1059	1.74	607
0	1245	1.86	669
5	1443	1.96	736
10	1655	2.04	810

Test Condition: Subcooling 3 K, Return Gas 20 °C.

PERFORMANCE CURVE

Ambient Temperature 43°C

Evaporating Temperature °C	Cooling Capacity W	Efficiency W/W	Consumo de Potencia W
-15	578	1.15	502
-5	880	1.39	635
0	1040	1.47	708
5	1209	1.53	789

Test Condition: Subcooling 3 K, Return Gas 20 °C.

ENVELOPE

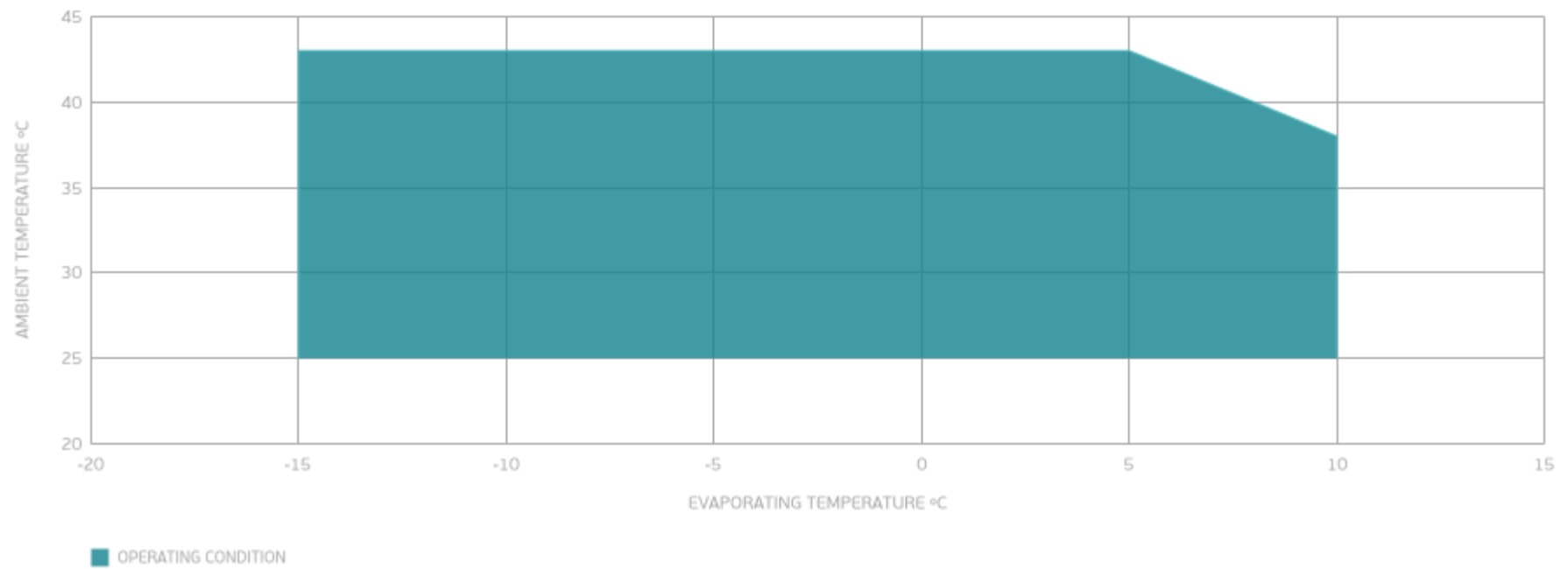

EXTERNAL DIMENSIONS

